

Varenummer: 20192B50B50652BL
Beskrivelse: E+G
T-rørs holder GN192-B50-B50-65-2-BL

Mål

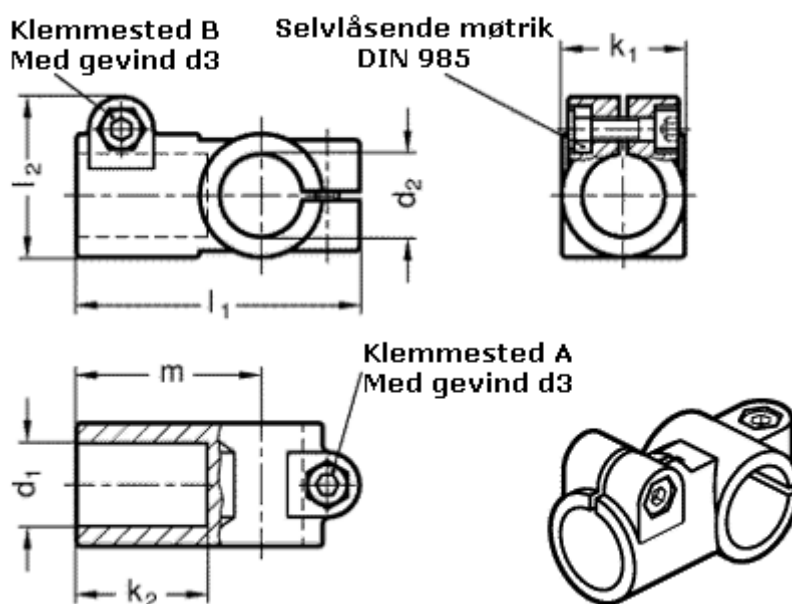

$d_1 = B50$
 $d_2 = B50$
 $d_3 = M10$
 $k_1 = 65$
 $k_2 = 75.0$
 $l_1 = 148$
 $l_2 = 77.5$
 $m = 103$